

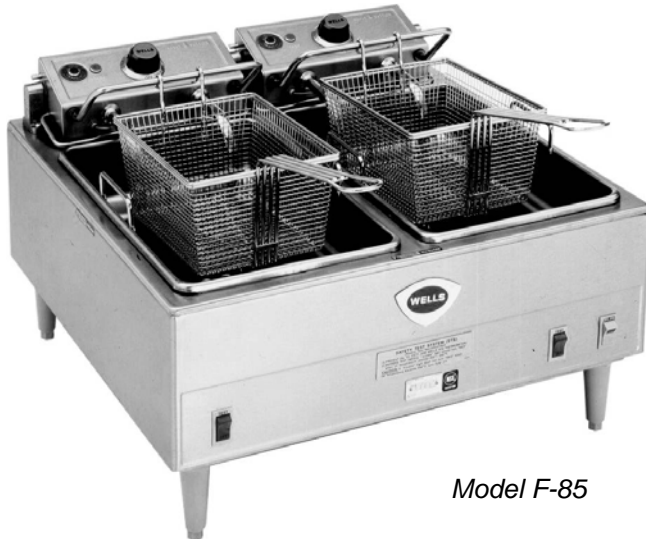

WELLS BLOOMFIELD, LLC
2 ERIK CIRCLE, P. O. Box 280 Verdi, NV 89439
telephone: 775-689-5703
fax: 775-689-5976
www.wellsbloomfield.com

302

OPERATION MANUAL



Model F-85



Model F-1725

MODEL F-55 STS F-101 F-1725 SINGLE HEAD and F-85 DUAL HEAD COUNTERTOP FRYERS with SAFETY TEST SYSTEM™

**Includes
INSTALLATION
USE & CARE**

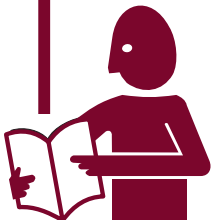

IMPORTANT: DO NOT DISCARD THIS MANUAL

This manual is considered to be part of the appliance and is to be given to the OWNER or MANAGER of the restaurant, or to the person responsible for TRAINING OPERATORS of this appliance. Additional manuals are available from your WELLS DEALER.

THIS MANUAL MUST BE READ AND UNDERSTOOD BY ALL PERSONS USING OR INSTALLING THIS APPLIANCE. Contact your WELLS DEALER if you have any questions concerning installation, operation or maintenance of this equipment.

PRINTED IN UNITED STATES OF AMERICA

LIMITED WARRANTY STATEMENT

Unless otherwise specified, all commercial cooking equipment manufactured by WELLS BLOOMFIELD, LLC is warranted against defects in materials and workmanship for a period of one year from the date of original installation or 18 months from the date of shipment from our factory, whichever comes first, and is for the benefit of the original purchaser only.

THIS WARRANTY IS THE COMPLETE AND ONLY WARRANTY, EXPRESSED OR IMPLIED IN LAW OR IN FACT, INCLUDING BUT NOT LIMITED TO, WARRANTIES OF MERCHANTABILITY OR FITNESS FOR ANY PARTICULAR PURPOSE, AND/OR FOR DIRECT, INDIRECT OR CONSEQUENTIAL DAMAGES IN CONNECTION WITH WELLS BLOOMFIELD PRODUCTS. This warranty is void if it is determined that, upon inspection by an authorized service agency, the equipment has been modified, misused, misapplied, improperly installed, or damaged in transit or by fire, flood or act of God. It also does not apply if the serial nameplate has been removed, or if service is performed by unauthorized personnel. The prices charged by Wells Bloomfield for its products are

based upon the limitations in this warranty. Seller's obligation under this warranty is limited to the repair of defects without charge by a Wells Bloomfield factory authorized service agency or one of its sub-service agencies. This service will be provided on customer's premises for non-portable models. Portable models (a device with a cord and plug) must be taken or shipped to the closest authorized service agency, transportation charges prepaid, for service. In addition to restrictions contained in this warranty, specific limitations are shown in the Service Policy and Procedure Guide. Wells Bloomfield authorized service agencies are located in principal cities. This warranty is valid in the United States and Canada and void elsewhere. Please consult your classified telephone directory, your foodservice equipment dealer or contact:

**Service Department, Wells Bloomfield, LLC
P.O. Box 280, Verdi, Nevada 89439
phone (775) 689-5707 or fax (775) 689-5976**

for information and other details concerning warranty.

SERVICE POLICY AND PROCEDURE GUIDE and ADDITIONAL WARRANTY EXCLUSIONS

1. Resetting of safety thermostats, circuit breakers, over load protectors, and/or fuse replacements are **not** covered by this warranty unless warranted conditions are the cause.
2. All problems due to operation at **voltages or phase other than specified on equipment nameplates** are **not** covered by this warranty. Conversion to correct voltage and/or phase must be the customer's responsibility.
3. All problems due to **electrical connections not made in accordance with electrical code requirements and wiring diagrams** supplied with the equipment are **not** covered by this warranty.
4. Replacement of items **subject to normal wear**, to include such items as knobs, light bulbs; and, normal maintenance functions including adjustments of thermostats, adjustment of micro switches and replacement of fuses and indicating lights are **not** covered by warranty.
5. Damage to electrical cords and/or plug due to exposure to excessive heat are **not** covered by this warranty.
6. Full use, care, and maintenance instructions supplied with each machine. Noted maintenance and preventative maintenance items, such as servicing and cleaning schedules, are customer responsibility. Those miscellaneous adjustments noted are customer responsibility. Proper attention to preventative maintenance and scheduled maintenance procedures will prolong the life of the appliance.
7. Travel mileage is limited to **sixty (60) miles** from an Authorized Service Agency or one of its sub-service agencies.
8. All labor shall be performed during regular working hours. Overtime premium will be charged to the buyer.
9. All genuine Wells replacement parts are warranted for ninety (90) days from date of purchase on non-warranty equipment. This parts warranty is limited only to replacement of the defective part(s). **Any** use of **non-genuine** Wells parts completely **voids any warranty**.
10. Installation, labor, and job check-outs are **not** considered warranty and are thus **not** covered by this warranty.
11. Charges incurred by delays, waiting time or operating restrictions that hinder the service technician's ability to perform service are **not** covered by warranty. This includes institutional and correctional facilities.

SHIPPING DAMAGE CLAIM PROCEDURE

NOTE: For your protection, please note that equipment in this shipment was carefully inspected and packaged by skilled personnel before leaving the factory. Upon acceptance of this shipment, the transportation company assumes full responsibility for its safe delivery.

IF SHIPMENT ARRIVES DAMAGED:

1. **VISIBLE LOSS OR DAMAGE:** Be certain that any visible loss or damage is noted on the freight bill or express receipt, and that the note of loss or damage is signed by the delivery person.
2. **FILE CLAIM FOR DAMAGE IMMEDIATELY:** Regardless of the extent of the damage.

3. **CONCEALED LOSS OR DAMAGE:** if damage is unnoticed until the merchandise is unpacked, notify the transportation company or carrier immediately, and file "CONCEALED DAMAGE" claim with them. This should be done within fifteen (15) days from the date the delivery was made to you. Be sure to retain the container for inspection.

Wells Bloomfield cannot assume liability for damage or loss incurred in transit. We will, however, at your request, supply you with the necessary documents to support your claim.

TABLE OF CONTENTS

WARRANTY	xi
SPECIFICATIONS	1
FEATURES & OPERATING CONTROLS	2
PRECAUTIONS & GENERAL INFORMATION	3
AGENCY LISTING INFORMATION	4
INSTALLATION	4
OPERATION	6
CLEANING INSTRUCTIONS	7
MAINTENANCE	8
TROUBLESHOOTING SUGGESTIONS	8
PARTS & SERVICE	9
CUSTOMER SERVICE DATA	9

INTRODUCTION

Thank You for purchasing this Wells Bloomfield appliance.

Proper installation, professional operation and consistent maintenance of this appliance will ensure that it gives you the very best performance and a long, economical service life.

This manual contains the information needed to properly install this appliance, and to use and care for the appliance in a manner which will ensure its optimum performance.

SPECIFICATIONS

MODEL	VOLTS	AMPS	WATTS
F-55 STS	208VAC 3 ϕ	L1 = 15.9A / L2 = 15.9A / L3 = 15.9A	5,750W
	240VAC 3 ϕ	L1 = 13.8A / L2 = 13.8A / L3 = 13.8A	5,750W
F-85	208VAC 3 ϕ	L1 = 31.9A / L2 = 31.9A / L3 = 31.9A	11,500W
	240VAC 1 ϕ	47.9A	11,500W
	240VAC 3 ϕ	L1 = 27.6A / L2 = 27.6A / L3 = 27.6A	11,500W
	480VAC 3 ϕ	L1 = 13.8A / L2 = 13.8A / L3 = 13.8A	11,500W
F-85EU	380-415VAC 3 ϕ	L1 = 16.0A / L2 = 16.0A / L3 = 16.0A	11,100W
F-101	208VAC 3 ϕ	L1 = 33.3A / L2 = 33.3A / L3 = 33.3A	12,000W
	240VAS 3 ϕ	L1 = 28.9A / L2 = 28.9A / L3 = 28.9A	12,000W
F-1725	208VAC 3 ϕ	L1 = 47.8A / L2 = 47.8A / L3 = 47.8A	17,250W
	240VAC 3 ϕ	L1 = 41.5A / L2 = 41.5A / L3 = 41.5A	17,250W

FEATURES & OPERATING CONTROLS

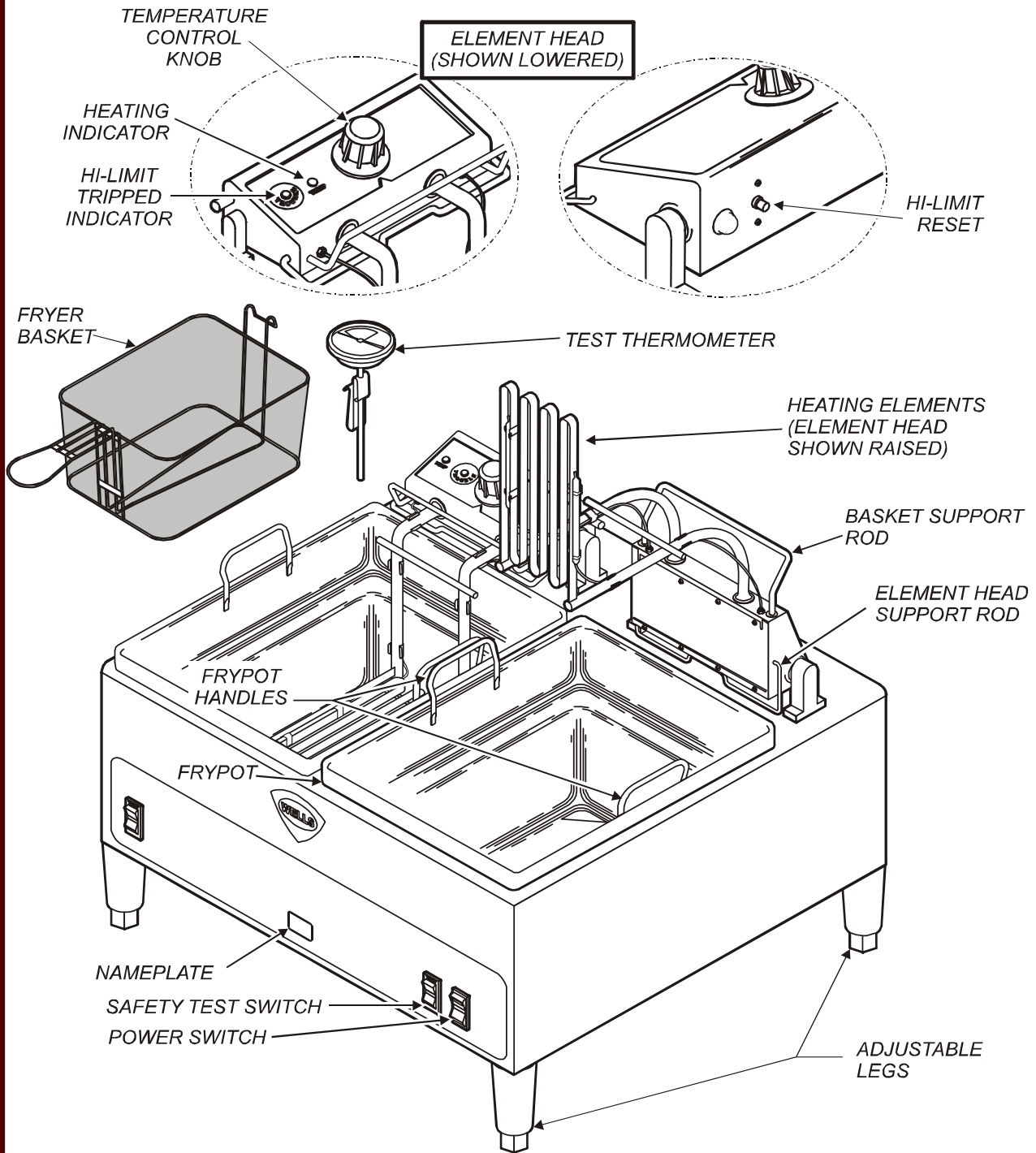

Fig. 1 Countertop Fryer with Safety Test System™ Features & Operating Controls
 F-85 Shown - F-55STS, F-101 and F1725 are Similar

302 p/n 304356 Opm CT Fryers STS

PRECAUTIONS AND GENERAL INFORMATION



DANGER: BURN HAZARD

Contact with hot oil will cause severe burns. Always wear protective clothing and heat resistant gloves when operating the fryer or filtering the oil.



WARNING: ELECTRIC SHOCK HAZARD

All servicing requiring access to non-insulated components must be performed by qualified service personnel. DO NOT open any access panel that requires the use of tools. Failure to heed this warning may result in severe electric shock.



CAUTION: BURN HAZARD

Contact with hot oil may cause burns. DO NOT fill fryer beyond MAX OIL line on frypot. For disposal of oil use only a container specifically designed for the disposal of hot oil. DO NOT fill hot oil disposal container beyond MAX OIL line.

This appliance is intended for use in commercial establishments only.

This appliance is intended to prepare food for human consumption. No other use is recommended or authorized by the manufacturer or its agents.

Operators of this appliance must be familiar with the appliance use, limitations and associated restrictions. Operating instructions must be read and understood by all persons using or installing this appliance.

Cleanliness of this appliance is essential to good sanitation. Read and follow all included cleaning instructions and schedules to ensure the safety of the food product.

Disconnect this appliance from electrical power before performing any maintenance or servicing.

DO NOT submerge this appliance in water. This appliance is not jet stream approved. Do not direct water jet or steam jet at this appliance, or at any control panel or wiring. Do not splash or pour water on, in or over any controls, control panel or wiring.

Exposed surfaces of this appliance can be hot to the touch and may cause burns.

The technical content of this manual, including any wiring diagrams, schematics, parts breakdown illustrations and/or adjustment procedures, is intended for use by qualified technical personnel.

Any procedure which requires the use of tools must be performed by a qualified technician.

Refer to the *General Layout Data* packed with the fryer for wire size requirements, clearances and other important installation data.

This manual is considered to be a permanent part of the appliance. This manual and all supplied instructions, diagrams, schematics, parts breakdown illustrations, notices and labels must remain with the appliance if it is sold or moved to another location.

This appliance is made in the USA. Unless otherwise noted, this appliance has American sizes on all hardware.



CAUTION: RISK OF DAMAGE

DO NOT connect or energize this appliance until all installation instructions are read and followed. Damage to the appliance will result if these instructions are not followed.



CAUTION: HOT SURFACE

Exposed surfaces can be hot to the touch and may cause burns.

AGENCY LISTING INFORMATION

This appliance conforms to NSF Standard 4 for sanitation only if installed in accordance with the supplied *Installation Instructions* and maintained according to the instructions in this manual.

This appliance is  Listed under UL File E6070 for 120V, 208V and 240V.



INSTALLATION

UNPACKING & INSPECTION

Carefully remove the appliance from the carton. Remove all protective plastic film, packing materials and accessories from the Appliance before connecting electrical power or otherwise performing any installation procedure.

Carefully read all instructions in this manual and the *Installation Instruction Sheet* packed with the appliance before starting any installation.

Read and understand all labels and diagrams attached to the appliance.

Carefully account for all components and accessories before discarding packing materials. Store all accessories in a convenient place for later use.

COMPONENTS

- 1 ea. FRYPOT (all except F-85) or 2 ea. FRYPOT (F-85)
- 2 ea. FRY BASKETS
- 4 ea. ADJUSTABLE LEGS

SETUP

Setup the appliance only on a firm, level, non-combustible surface. Verify local codes for requirements. Concrete, tile, terrazzo or metal surfaces are recommended. Metal over combustible material may not meet code for non-combustible surfaces.

Install one adjustable leg at each corner of the fryer by screwing the leg into the fitting on the bottom. With a spirit level, check that the appliance is level front-to-back and side-to-side. Verify that the unit sits firmly **ON ALL FOUR LEGS**.

The lower portions of the legs are adjustable by turning; adjust as required to level the appliance. All four legs must be adjusted to firmly contact the counter in order to prevent tipping.

Refer to the *Installation Instruction Sheet* for required clearances. Maintain required clearances between the appliance and adjacent combustible surfaces.

Avoid storing flammable or combustible materials in, on or near the appliance.

NOTE: DO NOT discard the carton or other packing materials until you have inspected the appliance for hidden damage and tested it for proper operation. Refer to *SHIPPING DAMAGE CLAIM PROCEDURE* on the inside front cover of this manual.

IMPORTANT:

This installation must comply with all applicable Federal, Local and NFPA codes.

SCREW INTO CABINET
MOUNTING HOLES



TURN TO
ADJUST HEIGHT

Fig. 2 Adjustable Legs



WARNING: ELECTRIC SHOCK HAZARD

All servicing requiring access to non-insulated electrical components must be performed by a factory authorized technician. DO NOT open any access panel which requires the use of tools. Failure to follow this warning can result in severe electrical shock.

IMPORTANT: Refer to the *General Layout Data* packed with the fryer for wire size requirements and other installation data.

F-55 STS FRYER ELECTRICAL INSTALLATION

F-55 fryers must be connected directly to an appropriately sized electric circuit. Conduit and strain relief must be provided by the electrician. F-55 fryers require a 208VAC or 240VAC 20 amp three-phase circuit with ground.

Raise the element head, remove the frypot and the cover at the inside rear of the fryer to gain access to the terminal block. The electrical inlet is provided by a knock-out in the rear panel.

If an equipment shutdown interface is required by local fire code, the flame sensor terminal block may be accessed by removing the cover at the inside rear of the fryer. Replace the jumper of the terminal block with wiring to a normally closed contact of the building fire management system.

DO NOT connect power to the flame sensor terminal block. Wiring and contacts must be capable of handling 20 amps.

F-85 FRYER ELECTRICAL INSTALLATION

F-85 fryers must be connected directly to an appropriately sized electric circuit. Conduit and strain relief must be provided by the electrician. F-85 fryers require either a 240VAC 50 amp single phase circuit with ground; a 208VAC or 240VAC 40 amp three phase circuit with ground, or a 480VAC 20 amp three phase circuit with ground. Units are shipped from the factory wired for three phase. Conversion of 240VAC units to single phase must be performed in the field by the electrician.

Raise the element head, remove the frypot and the cover at the inside rear of the fryer to gain access to the terminal block. The electrical inlet is provided by a knock-out in the rear panel.

F-101 and F-1725 FRYER ELECTRICAL INSTALLATION

F-101 and F-1725 fryers must be connected directly to an appropriately sized electric circuit. Conduit and strain relief must be provided by the electrician. F-101 fryers require a 208VAC or 240VAC 40 amp three phase circuit with ground, F-1725 fryers require a 208VAC or 240VAC 50 amp three phase circuit with ground, Units are shipped from the factory wired for three phase. F-101 and F-1725 fryers are not approved for conversion to single phase.

Raise the element head, remove the frypot and the cover at the inside rear of the fryer to gain access to the terminal block. The electrical inlet is provided by a knock-out in the rear panel.



**CAUTION:
RISK OF
DAMAGE**

DO NOT connect or energize this appliance until all installation instructions are read and followed. Damage to the appliance will result if these instructions are not followed.



**CAUTION:
ELECTRIC
SHOCK HAZARD**

The ground lug of fryers must be connected to a suitable building electric ground.

IMPORTANT:

Damage due to being connected to the wrong voltage or phase is NOT covered by warranty.

OPERATION



DANGER: BURN HAZARD

Contact with hot oil will cause severe burns.

Always wear protective clothing and heat resistant gloves when operating the fryer.



CAUTION: HOT SURFACE

Exposed surfaces can be hot to the touch and may cause burns.

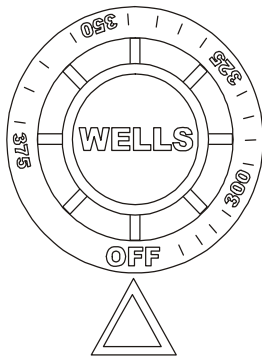

Fig. 3 Temperature Control Knob

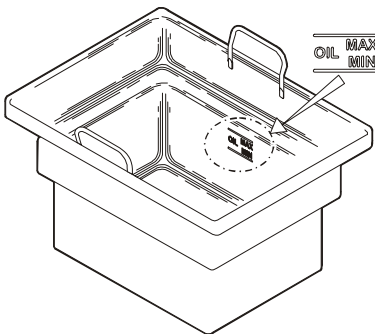

Fig. 4 Oil Level Marking

NOTE: If the oil temperature exceeds 440°F, the hi-limit safety will shut down the unit, and light the red **TROUBLE** light. To reset: Allow the oil to cool, then press the red button on the back of the element head until it “clicks” and stays in. If tripping persists, see Troubleshooting Suggestions, page 9.

NORMAL OPERATION

- Be sure the TEMPERATURE CONTROL KNOB is turned to **OFF**.
 - Lower the ELEMENT HEAD into the frypot by pushing back on the BASKET SUPPORT ROD, raising the ELEMENT HEAD SUPPORT ROD, then carefully lowering the elements.
- Fill the FRYPOT with commercial-grade liquid shortening to the MIN OIL line.
Capacity: 15 pounds (F-55), OR 30 pounds (F-85, F-101, F-1725).
IMPORTANT: DO NOT overfill the frypot. Cold oil will expand as it heats. Adding too much oil will allow the frypot to overflow during operation.
For best results, always use top grade commercial shortening made specially for frying. Maintain proper oil level in frypot during operation.
- Press the POWER SWITCH to the **ON** position. The indicator in the switch will glow.
- Turn the TEMPERATURE CONTROL KNOB to the desired temperature. The HEAT INDICATOR will glow. When the oil reaches the desired temperature, the heat indicator will go out. The heat indicator will go off and on during operation as the thermostat cycles to maintain temperature.
For best results: DO NOT set temperature control to a temperature setting higher than is required for the food product.
- Load either or both baskets no more than 1/2 full with food product.
 - DO NOT overload fry baskets. For best results, load baskets uniformly to half full.
 - Using the basket handle, lower the baskets into the hot oil.
 - When food is cooked, lift the basket out of the oil by the handle. Hang the baskets on the BASKET SUPPORT ROD to drain.
- When the heat indicator light cycles off, the fryer is ready to cook the next load.
- Reduce temperature control to 225°F during idle periods to save power and extend the life of the oil. The fryer will return to operating temperature in just a few minutes when needed.
- Keep the fryer clean at all times. Rinse baskets frequently, and dry thoroughly, in order to prevent oil contamination.
- Drain the frypot completely after use. Filter the oil daily, or more often during heavy use.



DANGER: BURN HAZARD

Contact with hot oil will cause severe burns. Allow the fryer to cool before cleaning. Always wear protective clothing and heat resistant gloves when performing this test.

1. Fill the frypot to the MIN OIL line. Fresh oil is recommended to minimize smoking.
2. Clip the TEST THERMOMETER to a FRYER BASKET. Lower the fryer basket into the oil. Be sure the dial of the test thermometer can be clearly viewed.
3. Turn the TEMPERATURE CONTROL KNOB to the maximum setting, then press the POWER SWITCH to ON. Allow the oil to heat until the test thermometer reads to "START TEST" (350°F).
4. Press and hold the red TEST SWITCH. The temperature of the oil will rise, and the test thermometer will read "TEST ZONE".

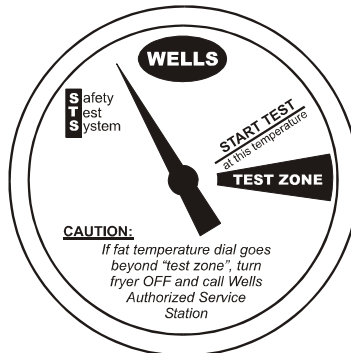

Fig. 5 Test Thermometer

IMPORTANT: DO NOT hold the TEST switch for more than 2-1/2 minutes.

When the oil temperature reaches the setting of the hi-limit thermostat, the hi-limit will trip, the red TROUBLE light will glow, and the heating element will be de-energized.



If the hi-limit thermostat trips while the test thermometer is in the TEST ZONE, the test is complete. The function of the hi-limit thermostat is normal. Reset the hi-limit thermostat and resume normal operation.



If the test thermometer rises above the TEST ZONE, the hi-limit is not operating properly. Release the TEST switch, turn the power switch OFF and contact an Authorized Wells Service Agent for repairs.

5. Reset the hi-limit thermostat:
 - a. Turn the power switch OFF
 - b. Allow the oil to cool
 - c. Press the red button on the back of the element head until it "clicks" and stays in.
6. Remove, clean and store the test thermometer. Set the temperature control knob to the normal operating temperature. Turn the power switch ON and resume normal operation.

The Safety Test System™ allows a positive test of the function of the temperature limiting (hi-limit) thermostat.

The hi-limit thermostat is factory set for 440°F (227°C). It will trip if the oil temperature exceeds this setting, and interrupt power to the heating element.



CAUTION FIRE HAZARD

Do not hold the TEST switch for more than 2-1/2 minutes. Should the oil temperature not reach the hi-limit setting within 2-1/2 minutes, turn the power switch OFF and contact an Authorized Wells Service Agent for repairs.

CLEANING INSTRUCTIONS



DANGER: BURN HAZARD

Contact with hot oil will cause severe burns. Allow the fryer to cool before cleaning. Always wear protective clothing and heat resistant gloves when cleaning the fryer.



CAUTION: ELECTRIC SHOCK HAZARD

Disconnect fryer from electric power before cleaning.



CAUTION: BURN HAZARD

Allow fryer to cool completely before cleaning.



CAUTION: ELECTRIC SHOCK HAZARD

Do not submerge fryer in water.

IMPORTANT: DO NOT spill or pour water into controls, control panel or wiring.

DO NOT submerge fryer in water. Damage to internal components will occur. Damage to internal components from water damage is **not** covered by warranty.

IMPORTANT: DO NOT use steel wool or abrasive cleansers for cleaning the fryer cabinet or frypot.

To remove carbonization from frypot and element, see *PERIODIC CLEANING* on page 10.

IMPORTANT:
Nickel plated frypot must be dried completely in order to prevent rusting, and to eliminate water contamination of the cooking oil.

PREPARATION

Turn temperature control to *OFF*
Allow fryer to cool completely before cleaning
Unplug fryer from receptacle before cleaning

FREQUENCY

Daily, or as needed

TOOLS

Mild Detergent, Non-abrasive cleanser
Soft Cloth or Sponge, Plastic Scouring Pad
Container for disposal of used oil.

CLEANING

1. Turn temperature control to OFF. Unplug the fryer.
2. Remove fry baskets, then swing the element head up and out of the frypot.
NOTE: The element support rod is spring-loaded. When the element head is raised, the support rod will automatically swing into position to keep the element head raised.
3. Allow the oil to cool to a safe temperature (120°F or less). Carefully remove the frypot: wearing heat-resistant gloves, lift the frypot by the handles. Drain the oil into a suitable container.
4. Frypot and baskets may be washed in a dishwasher, or with warm water and mild detergent. Rinse thoroughly and dry completely.
5. Wipe/brush all crumbs, breading and cooking debris from elements. Pay particular attention to the area between the element and the thermobulbs. Be careful that the capillary tubes of the thermobulbs are not moved or damaged during cleaning.
6. Keep all exterior surfaces free from splashed grease by wiping with a clean cloth dampened with warm water and mild detergent. A non-abrasive detergent and plastic scouring pad may be used for stubborn deposits.
IMPORTANT: DO NOT use steel wool or abrasive cleansers as these will damage the surface finish.
IMPORTANT: DO NOT submerge fryer in water. DO NOT spill or pour water into controls, control panel or wiring. Damage to internal components will occur.
7. Be certain frypot is completely dry, then reinstall in fryer.
 - a. Be sure the TEMPERATURE CONTROL KNOB is turned to *OFF*, then plug unit into receptacle.
 - b. Lower the ELEMENT HEAD into the frypot by pushing back on the ELEMENT LIFTING HANDLE, raising the SUPPORT ROD, then carefully lowering the elements.
 - c. Add new or filtered oil to the MIN OIL line in frypot

Procedure is complete.



DANGER: BURN HAZARD

Contact with hot oil will cause severe burns. Allow the fryer to cool before cleaning. Always wear protective clothing and heat resistant gloves when handling hot oil.

- PREPARATION** Turn temperature control to *OFF*
Allow fryer to cool completely before draining
- FREQUENCY** Daily, or as needed
- TOOLS** Container for disposal of used oil.



**CAUTION:
BURN HAZARD**

Allow fryer to cool completely before draining.

OIL DISPOSAL

1. Turn temperature control to OFF.
2. Allow the oil to cool to a safe temperature (120°F or 50°C).
3. Raise the element head and lift the frypot out of the fryer by the frypot handles.
4. Dispose of the used oil in an approved oil disposal receptacle, or filter the oil for reuse.
5. Wipe the frypot and reinstall in the fryer.

Procedure is complete.



**CAUTION:
SLIP AND FALL
HAZARD**

Clean up oil spills immediately. Slipping in oil can cause injury.



**CAUTION:
HEALTH
HAZARD**

Clean up oil spills immediately. Oil provides an environment for the growth of bacteria, which presents a health hazard.

TROUBLESHOOTING SUGGESTIONS

DESCRIPTION	POSSIBLE PROBLEM	SUGGESTED REMEDY
Fryer will not heat	Not plugged in or circuit breaker tripped	Plug into proper receptacle Reset circuit breaker
	Temperature control knob not set to desired temperature	Set to desired temperature
	Hi-limit safety tripped	Clean element ¹ , reset hi-limit
	Damaged internal component	Contact Wells Authorized Service Agency for repairs
Fryer will not maintain temperature	Temperature control thermostat thermobulb contaminated with cooking debris	Clean element ²
	Damaged internal component	Contact Wells Authorized Service Agency for repairs
Fryer leaks oil	Damaged frypot	Contact Wells Authorized Service Agency for repairs
Element head will not raise, will not stay in the up position, or will not lower	Frypot out of position, or has excess cooking debris in bottom	Check frypot for position Clean frypot
	Damaged hinge bracket or support rod	Contact Wells Authorized Service Agency for repairs

¹ The hi-limit safety is designed to shut down the fryer if the oil temperature exceeds 440°F. A build-up of cooking debris between the heating element and the thermobulb of the hi-limit safety will cause the hi-limit to trip prematurely. Clean the element so that oil may circulate freely between the element and the thermobulb. Reset the safety by pressing the red button on the basket of the element head.

² A build-up of cooking debris between the heating element and the thermobulb temperature control thermostat will cause inconsistent temperatures. Clean the element so that oil may circulate freely between the element and the thermobulb.

MAINTENANCE

Frypot may be cleaned by the method described at right, or with a commercial frypot cleaner. Be sure to follow the manufacturer's directions.

Before cleaning, ALWAYS:

- Unplug the fryer and allow to cool.
- Drain the oil and wipe out the frypot.

IMPORTANT:

Nickel plated frypot must be dried completely in order to prevent rusting, and to eliminate water contamination of the cooking oil.

PERIODIC CLEANING

Periodic cleaning is necessary to remove carbonization from the elements and frypot.

Add 1/2 cup of granulated dishwasher detergent to frypot. Fill with water to the MAX OIL line.

Lower the element into the frypot and set the control knob to 225°F

Boil the mixture for five minutes. Turn the control knob to OFF. Allow the mixture to set in the frypot overnight.

After the soak period, raise the elements and remove any remaining carbonization with a stiff bristle brush. Be careful that the capillary tubes of the thermobulbs are not moved or damaged during cleaning.

Drain the frypot and wash with warm water and mild detergent.

Reinstall the frypot in the fryer. Add 1 quart of vinegar, then fill to the MAX OIL line with cold water.

Lower the elements into the vinegar solution. Allow to set for 15 minutes.

Drain the frypot and rinse with clean water. Dry the frypot and elements thoroughly before returning the fryer to operation.

DESCRIPTION

PART NO.

FRY BASKET, HALF-SIZE FOR F-55, F-85	20161
FRY BASKET, FULL SIZE FOR F-55, F-85	20162
FRYPOT, FOR F-101	20167
FRYPOT, FOR F-55, F-85	20169
FRY BASKET, HALF-SIZE FOR F-101	20287
FRYPOT, FOR F-1725	20519
THERMOMETER, TEST	20537
FRY BASKET, HALF-SIZE FOR F-1725	20820
COVER, FRYPOT FOR F-101, F-1725	21009
COVER, FRYPOT FOR F-55, F-85	21010
LEGS, ADJUSTABLE (Set of 4)	20563
CRUMB CRADLE, FOR F-55, F-85	20690

IMPORTANT: Use only factory authorized service parts and replacement filters.

For factory authorized service, or to order factory authorized replacement parts, contact your Wells authorized service agency, or call:

Wells Bloomfield, LLC

2 Erik Circle
P. O. Box 280
Verdi, NV 89439

Service Parts Dept.
phone: (775) 689-5707
fax: (775) 689-5976

Service Parts Department can supply you with the name and telephone number of the WELLS AUTHORIZED SERVICE AGENCY nearest you.

CUSTOMER SERVICE DATA

please have this information available if calling for service

RESTAURANT _____ LOCATION _____
 INSTALLATION DATE _____ TECHNICIAN _____
 SERVICE COMPANY _____
 ADDRESS _____ STATE _____ ZIP _____
 TELEPHONE NUMBER (____) _____ - _____

EQUIPMENT MODEL NO. _____
 EQUIPMENT SERIAL NO. _____

VOLTAGE: 208 240 1Ø 3Ø



Wells Bloomfield proudly supports CFESA
Commercial Food Equipment Service Association

SERVICE TRAINING - QUALITY SERVICE



CUSTOMER SATISFACTION



WELLS BLOOMFIELD, LLC
2 ERIK CIRCLE, P. O. Box 280 Verdi, NV 89439
telephone: 775-689-5703
fax: 775-689-5976
www.wellsbloomfield.com

PRINTED IN UNITED STATES OF AMERICA